

Varenummer: 2310431037  
Beskrivelse: E+G Stilleben  
LX.40-SW17-M8X50

## Mål

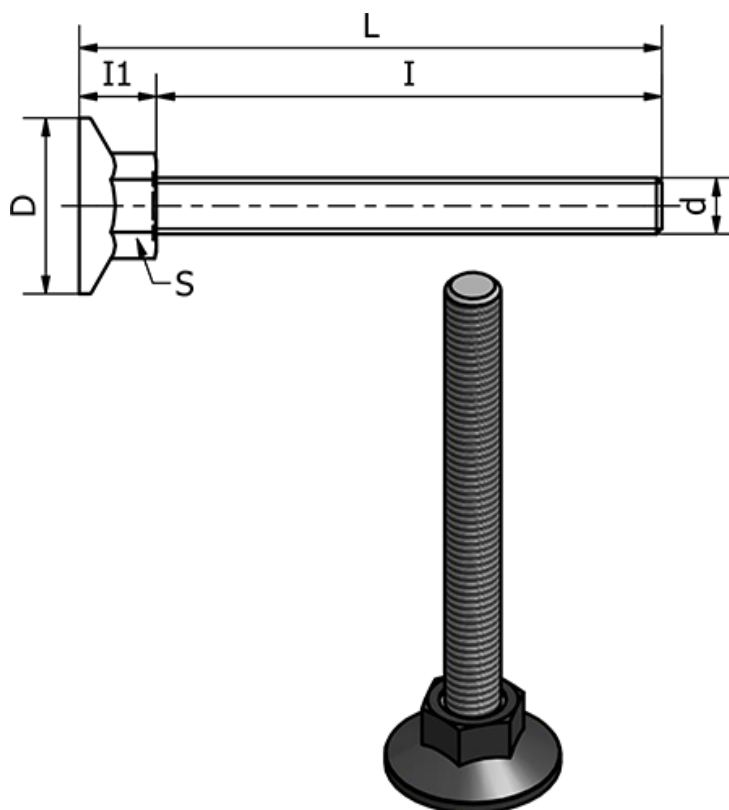

|                            |             |
|----------------------------|-------------|
| d                          | = M8        |
| D                          | = 40        |
| I                          | = 50        |
| I1                         | = 13        |
| L                          | = 62.5      |
| Max statisk belastning (N) | = 2500      |
| S                          | = 17        |
| Type                       | = Forzinket |

Vægt (g) = -